

Features

- Front and side diffuser, no visible LED's
- Plug-in mirror, saves on install time
- All hardware with security bracket included
- Energy efficient LED lighting: (measurements may vary)

Kelvin	2700
CRI	90+
Lumens* (Estimated)	1120
R9 Value*	50+
Watt Output - LED with optional defogger on	85w max

* Mirror measured not the raw LED.
Based on 30" x 40" Mirror

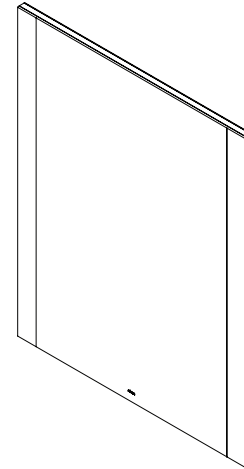

Construction

- Anodized aluminum back frame
- Quality polished edge mirror
- Power cords installed for easy plugin installation
- Constructed for surface mounting
- Includes installation hardware

Codes/Standards Applicable

Vitality Mirror is UL certified to:

- UL 962
- CSA-C22.2, No. 250.4

Dimensions

Height: 30" (762 mm)
Width: 24" (610 mm)
Depth: 1-3/4" (45 mm)

Electrical System

- 120 Vac 60Hz wall outlet as shown in drawing

Options

- Mirror defogging
- Dimmable LED task lighting to 1%
- Compatible with most Triac/Phase-cut dimmers

Model Number Key

Vitality	Mirror	Width	Height	Shape	Light Pattern	Edge Type	Defogger	Color Temp
Y	M	24	30	R = Rectangle	S = Edge Lit	FP = Flat, Polished	D = Defogger Included	3 = 2700K

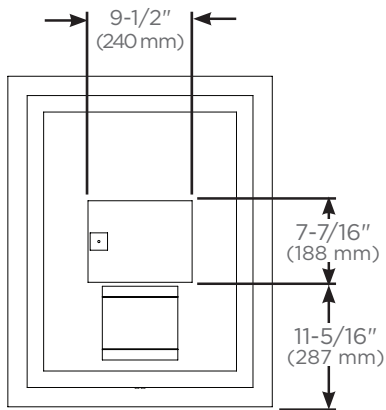

Back view for defogger location

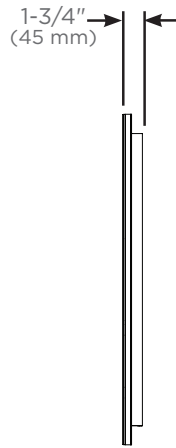

Side view

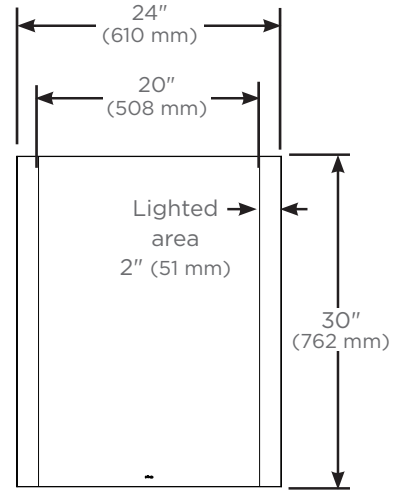

Front view

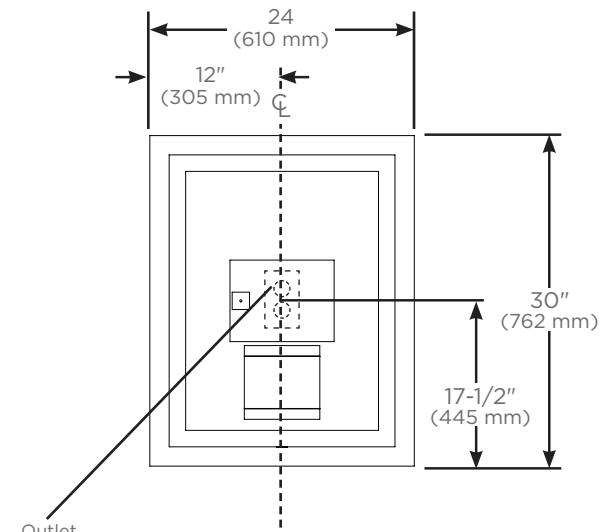

Back view for electrical outlet location

† See instructions for wiring and location