

Royal Modular 2.0
800200111105200 Mirror cabinet

PRODUCT

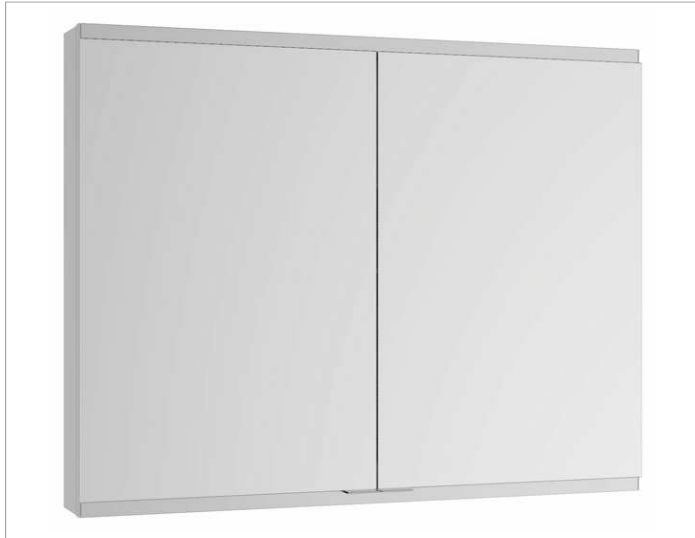

DRAWING

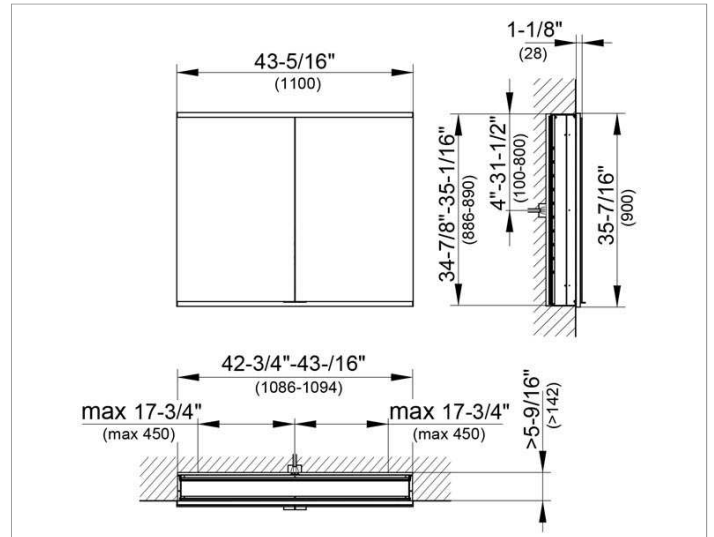

SURFACE

silver anodized

DIMENSION

43,31 x 35,43 x 6,3 "

Warranty: KEUCO products are covered by a 5-year manufacturer's warranty, in effect from the date of purchase. During this time, proven product defects will be remedied free of charge. Warranty claims must be filed in writing, including a detailed description of the defect immediately after a defect has occurred. For a copy of our detailed product warranty policy, please contact us at office-usa@keuco.com.

Installation: KEUCO products must be installed by a qualified professional in accordance with the respective installation guidelines and any applicable federal / local building codes and regulations.