

BERLIN COLLECTION

TOWEL BAR-SOLID BACK

232240SB

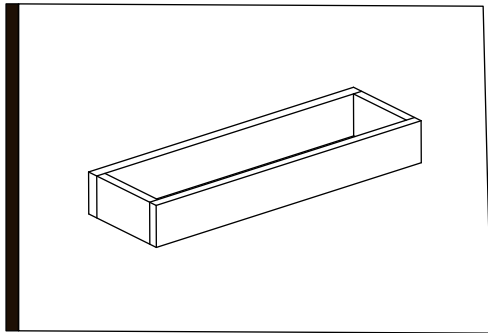

Tools required for installation

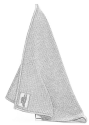

Cleaning cloth



UV Glue

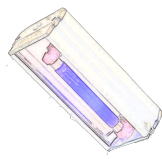

UV Lighting

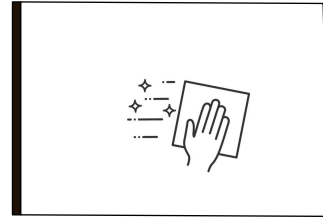

Step 1

Ensure that the glass is clean, dry, free of grease, and flat. (The grease, moisture, impurities, and flatness on the surface will directly affect the quality.)

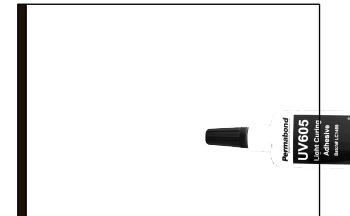

Step 2

Use an appropriate amount of UV shadowless adhesive to the surface of the glass to be adhered, then close it with the solid backing to expel possible bubbles.

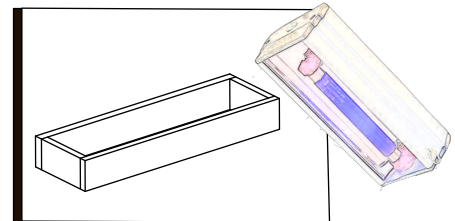

Step 3

When the solid backing is in a pressed state, it's irradiated by a UV lamp with a certain intensity of light or sunlight. The irradiation principle is from the middle to the periphery, ensuring that the light can penetrate the bonding area and solidify the UV adhesive on the bonding surface.

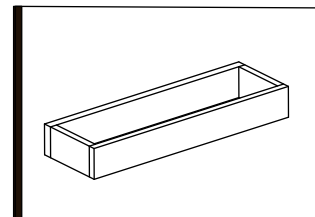

Step 4

We suggest this product be installed by a professional glazier.